

# SINGER<sup>®</sup>

TRUSTED INTERNATIONAL BRAND

MICROWAVE OVEN  
SMW30GCB8

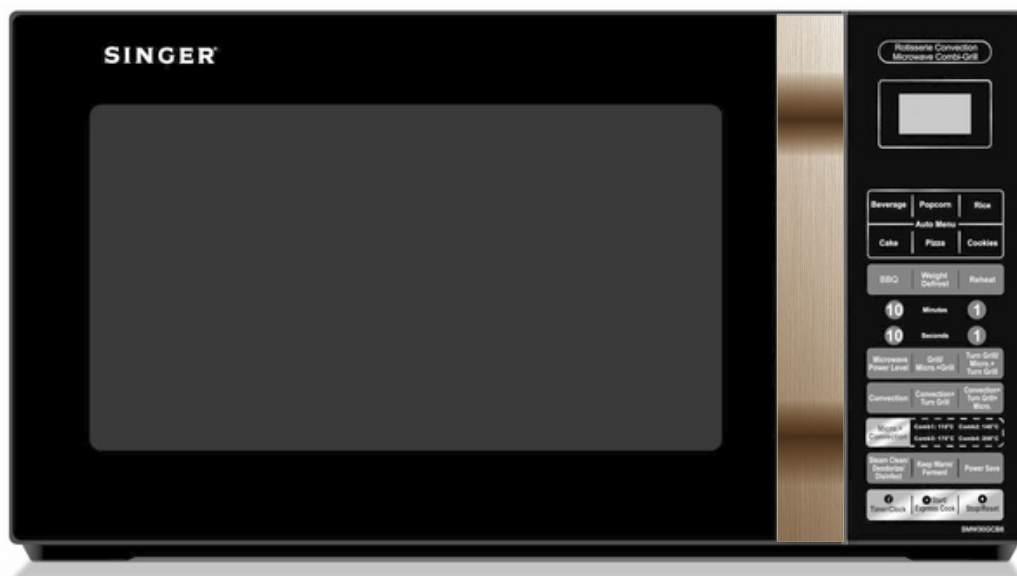

**900W**  
Microwave  
Power

**30L**  
Capacity

**2200W**  
Grill  
Power

**11**  
Power  
Levels

# USER MANUAL



# CONTENTS

SPECIFICATIONS .....	2
BEFORE YOU CALL FOR SERVICE .....	2
INSTALLATION .....	2
GROUNDING INSTRUCTIONS .....	3
RADIO INTERFERENCE .....	3
IMPORTANT SAFETY INSTRUCTIONS .....	3
MICROWAVE COOKING PRINCIPLES .....	5
UTENSILS GUIDE .....	6
PART NAMES .....	7
CONTROL PANEL .....	8
HOW TO SET THE OVEN CONTROLS.....	9
SETTING THE CLOCK.....	9
KITCHEN TIMER .....	9
MICROWAVE COOKING.....	9
GRILL/ MICROWAVE +GRILL .....	10
TURN GRILL/MICRO+TURN GRILL .....	10
CONVECTION.....	11
MICROWAVE +CONVECTION .....	11
CONVECTION+TURN GRILL .....	11
CONVECTION+TURN GRILL+MICRO .....	12
WEIGHT DEFROST .....	12
MENU COOK.....	13
OTHER CONVENIENT FEATURES .....	13
CLEANING AND CARE .....	16

## SPECIFICATIONS

Power Supply	230V/50Hz
Power Consumption (Microwave)	1400W
Power Consumption (Grill)	2200W
Power Consumption (Convection)	2200W
Rated Microwave Output	900W
Operation Frequency	2450MHz
Outside Dimensions	300mm(H)×539mm(W)×444mm(D)
Oven Cavity Dimensions	240mm(H)×354mm(W)×358mm(D)
Oven Capacity	30Litres
Cooking Uniformity	Turntable System
Net Weight	Approx. 18.4kg

## BEFORE YOU CALL FOR SERVICE

If the oven fails to operate:

1. Check to ensure that the oven is plugged in securely. If it is not, remove the plug from the outlet, wait 10 seconds, and plug it in again securely.
2. Check for a blown circuit fuse or a tripped main circuit breaker. If these seem to be operating properly, test the outlet with another appliance.
3. Check to ensure that the control panel is programmed correctly and the timer is set.
4. Check to ensure that the door is securely closed engaging the door safety lock system. Otherwise, the microwave energy will not flow into the oven.

IF NONE OF THE ABOVE RECTIFY THE SITUATION, THEN CONTACT A QUALIFIED TECHNICIAN.  
DO NOT TRY TO ADJUST OR REPAIR THE OVEN YOURSELF.

## INSTALLATION

1. Make sure that all the packing materials are removed from the inside of the door.
2. **WARNING:** Check the oven for any damage, such as misaligned or bent door, damaged door seals and sealing surface, broken or loose door hinges and latches and dents inside the cavity or on the door. If there is any damage, do not operate the oven and contact qualified service personnel.
3. This microwave oven must be placed on a flat, stable surface to hold its weight and the heaviest food likely to be cooked in the oven.
4. Do not place the oven where heat, moisture, or high humidity are generated, or near combustible materials.
5. For correct operation, the oven must have sufficient airflow. Allow 20cm of space above the oven,

10cm at back and 5cm at both sides. Do not cover or block any openings on the appliance. Do not remove feet.

6. Do not operate the oven without glass tray, roller support, and shaft in their proper positions.
7. Make sure that the power supply cord is undamaged and does not run under the oven or over any hot or sharp surface.
8. The socket must be readily accessible so that it can be easily unplugged in an emergency.
9. Do not use the oven outdoors.

## GROUNDING INSTRUCTIONS

This appliance must be grounded. This oven is equipped with a cord having a grounding wire with a grounding plug. It must be plugged into a wall receptacle that is properly installed and grounded. In the event of an electrical short circuit, grounding reduces risk of electric shock by providing an escape wire for the electric current. It is recommended that a separate circuit serving only the oven be provided. Using a high voltage is dangerous and may result in a fire or other accident causing oven damage.

**WARNING:** Improper use of the grounding plug can result in a risk of electric shock.

### Note

1. If you have any questions about the grounding or electrical instructions, consult a qualified electrician or service person.
2. Neither the manufacturer nor the dealer can accept any liability for damage to the oven or personal injury resulting from failure to observe the electrical connection procedures.

The wires in this cable main are colored in accordance with the following code:

**Green and Yellow = EARTH**

**Blue = NEUTRAL**

**Brown = LIVE**

## RADIO INTERFERENCE

Operation of the microwave oven can cause interference to your radio, TV, or similar equipment.

When there is interference, it may be reduced or eliminated by taking the following measures:

1. Clean door and sealing surface of the oven.
2. Reorient the receiving antenna of radio or television.
3. Relocate the microwave oven with respect to the receiver.
4. Move the microwave oven away from the receiver.
5. Plug the microwave oven into a different outlet so that microwave oven and receiver are on different branch circuits.

## IMPORTANT SAFETY INSTRUCTIONS

When using electrical appliance basic safety precautions should be followed, including the following:

**WARNING:** To reduce the risk of burns, electric shock, fire, injury to persons or exposure to excessive microwave energy:

1. Read all instructions before using the appliance.
2. Use this appliance only for its intended use as described in this manual. Do not use corrosive chemicals or vapors in this appliance. This type of oven is specifically designed to heat, cook or dry

- food. It is not designed for industrial or laboratory use.
3. Do not operate the oven when empty.
  4. Do not operate this appliance if it has a damaged cord or plug, if it is not working properly or if it has been damaged or dropped. If the supply cord is damaged, it must be replaced by the manufacturer or its service agent or a similarly qualified person in order to avoid a hazard
  5. **WARNING:** Only allow children to use the oven without supervision when adequate instructions have been given so that the child is able to use the oven in a safe way and understands the hazards of improper use.
  6. **Warning:** When the appliance is operated in the combination mode, children should only use the oven under adult supervision due to the temperatures generated.
  7. To reduce the risk of fire in the oven cavity:
    - a. When heating food in plastic or paper container, keep an eye on the oven due to the possibility of ignition;
    - b. Remove wire twist-ties from paper or plastic bags before placing bag in oven.
    - c. If smoke is observed, switch off or unplug the appliance and keep the door closed in order to stifle any flames.
    - d. Do not use the cavity for storage purposes. Do not leave paper products, cooking utensils or food in the cavity when not in use.
  8. **WARNING:** Liquid or other food must not be heated in sealed containers since they are liable to explode.
  9. Microwave heating of beverage can result in delayed eruptive boiling, therefore care has to be taken when handling the container.
  10. Do not fry food in the oven. Hot oil can damage oven parts and utensils and even result in skin burns.
  11. Eggs in their shell and whole hard-boiled eggs should not be heated in microwave ovens since they may explode even after microwave heating has ended.
  12. Pierce foods with heavy skins such as potatoes, whole squashes, apples and chestnuts before cooking.
  13. The contents of feeding bottles and baby jars should be stirred or shaken and the temperature should be checked before serving in order to avoid burns.
  14. Cooking utensils may become hot because of heat transferred from the heated food. Potholders may be needed to handle the utensil.
  15. Utensils should be checked to ensure that they are suitable for use in microwave oven.
  16. **WARNING:** It is hazardous for anyone other than a trained person to carry out any service or repair operation which involves the removal of any cover which gives protection against exposure to microwave energy.
  17. This product is a Group 2 Class B ISM equipment. The definition of Group 2 which contains all ISM (Industrial, Scientific and Medical) equipment in which radio-frequency energy is intentionally generated and/or used in the form of electromagnetic radiation for the treatment of material, and spark erosion equipment. For Class B equipment is equipment suitable for use in domestic establishments and in establishments directly connected to a low voltage power supply network which supplies buildings used for domestic purpose.
  18. This appliance is not intended for use by persons (including children) with reduced physical, sensory or mental capabilities, or lack of experience and knowledge, unless they have been given supervision or instruction concerning use of the appliance by a person responsible for their safety.
  19. Children should be supervised to ensure that they do not play with the appliance.
  20. The microwave oven is only used in freestanding.
  21. **WARNING:** Do not install oven over a range cooktop or other heat-producing appliance. if installed could be damaged and the warranty would be avoid .

22. The accessible surface may be hot during operation.
23. The microwave oven shall not be placed in a cabinet.
24. The door or the outer surface may get hot when the appliance is operating.
25. The temperature of accessible surfaces may be high when the appliance is operating.
26. The appliance shall be placed against a wall.
27. Appliance is not to be used by children or persons with reduced physical, sensory or mental capabilities, or lack of experience and knowledge, unless they have been given supervision or instruction
28. Children being supervised not to play with appliance
29. WARNING: If the door or door seals are damaged, the oven must not be operated until it has been repaired by a competent person
30. The instructions shall state that appliances are not intended to be operated by means of an external timer or separate remote-control system.
31. The microwave oven is for household use only and not for commercial use.
32. Never remove the distance holder in the back or on the sides, as it ensures a minimum distance from the wall for air circulation.
33. Please secure the turn table before you move the appliance to avoid damages.
34. Caution: It is dangerous to repair or maintain the appliance by no other than a specialist because under these circumstances the cover have to be removed which assures protection against microwave radiation. This applies to changing the power cord or the lighting as well. Send the appliance in these cases to our service centre.
35. The microwave oven is intended for defrosting, cooking and steaming of food only.
36. Use gloves if you remove any heated food.
37. Caution! Steam will escape, when opening lids or wrapping foil.
38. This appliance can be used by children aged from 8 years and above and persons with reduced physical, sensory or mental capabilities or lack of experience and knowledge if they have been given supervision or instruction concerning use of the appliance in a safe way and understand the hazards involved. Children shall not play with the appliance. Cleaning and user maintenance shall not be made by children unless they are aged from 8 years and above and supervised.
39. If smoke is emitted, switch off or unplug the appliance and keep the door closed in order to stifle.

## **MICROWAVE COOKING PRINCIPLES**

1. Arrange food carefully. Place thickest areas towards outside of dish.
2. Watch cooking time. Cook for the shortest amount of time indicated and add more as needed. Food severely overcooked can smoke or ignite.
3. Cover foods while cooking. Covers prevent spattering and help foods to cook evenly.
4. Turn foods over once during microwaving to speed cooking of such foods as chicken and hamburgers. Large items like roasts must be turned over at least once.
5. Rearrange foods such as meatballs halfway through cooking both from top to bottom and from the center of the dish to the outside.

## UTENSILS GUIDE

1. The ideal material for a microwave utensil is transparent to microwave, it allows energy to pass through the container and heat the food.
2. Microwave cannot penetrate metal, so metal utensils or dishes with metallic trim should not be used.
3. Do not use recycled paper products when microwave cooking, as they may contain small metal fragments which may cause sparks and/or fires.
4. Round /oval dishes rather than square/oblong ones are recommend, as food in corners tends to overcook.
5. Narrow strips of aluminum foil may be used to prevent overcooking of exposed areas. But be careful don't use too much and keep a distance of 1 inch (2.54cm) between foil and cavity.

The list below is a general guide to help you select the correct utensils.

Cookware	Microwave	Grill / Convection / Turn Grill	Combination*
Heat-Resistant Glass	Yes	Yes	Yes
Non Heat-Resistant Glass	No	No	No
Heat-Resistant Ceramics	Yes	Yes	Yes
Microwave-Safe Plastic Dish	Yes	No	No
Kitchen Paper	Yes	No	No
Metal Tray	No	Yes	No
Metal Rack	No	Yes	No
Baking Plate	No	Yes	No
Aluminum Foil & Foil Container	No	Yes	No

\* Combination: applicable for both "microwave + grill", "microwave + convection", "microwave + skewer" and "convection + microwave + turn grill" cooking.



## PART NAMES

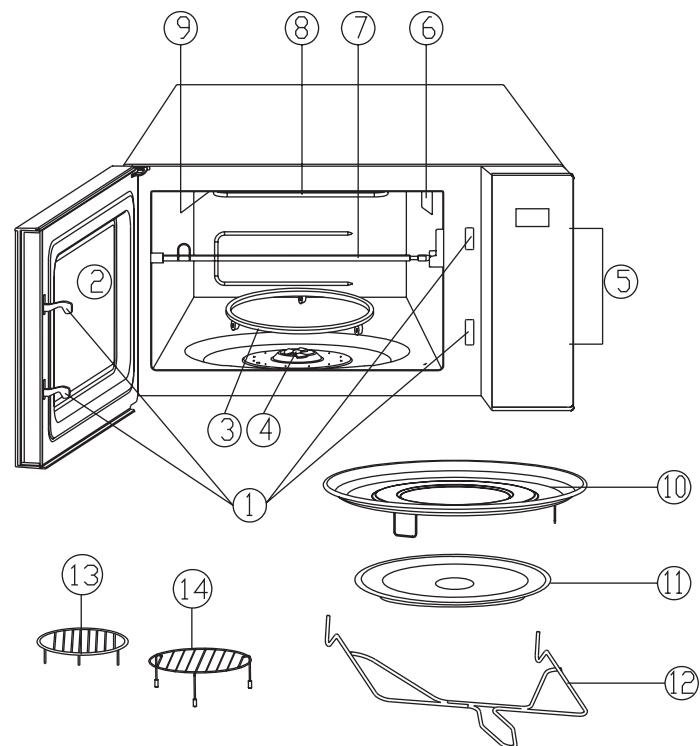

1. Door Safety Lock System
2. Oven Window
3. Roller Ring
4. Shaft
5. Control Panel
6. Wave guide (Please do not remove the mica plate covering the wave guide)
7. Rotisserie Rack
8. Grill Heater 1
9. Grill Heater 2
10. Baking Plate (For Grill And/Or Convection Cooking Only)
11. Glass Turntable
12. Handle
13. Metal Rack (For Grill And/Or Convection Cooking Only)
14. Metal Rack (For Grill And/Or Convection Cooking Only)

# CONTROL PANEL

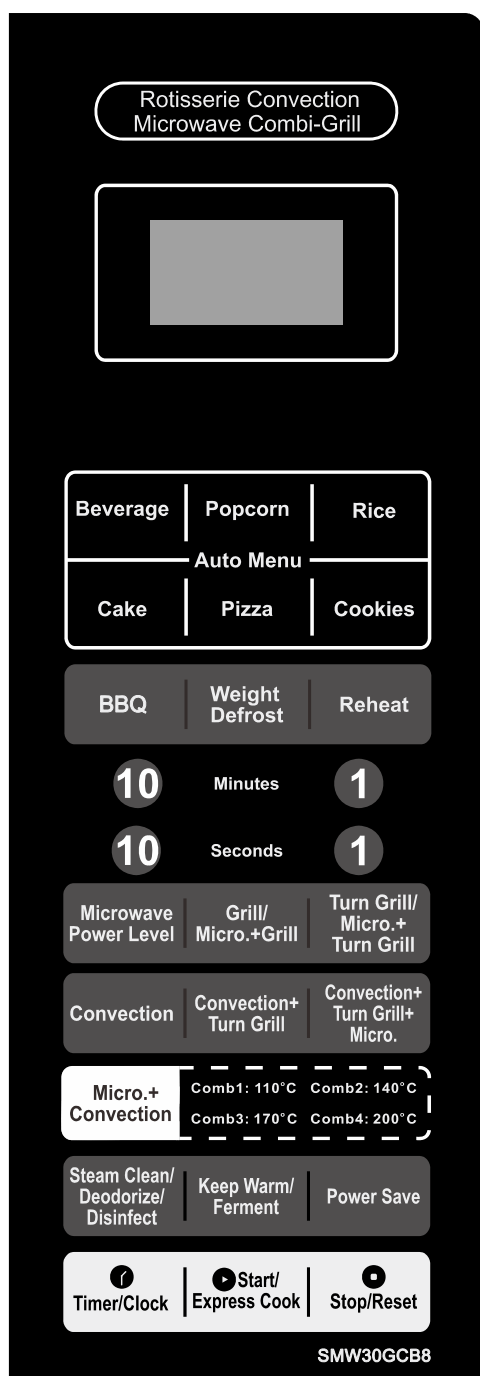

## DISPLAY WINDOW

Used to indicate clock, cooking time, power, etc.

## AUTO MENU

Instant settings to cook popular foods.

## WEIGHT DEFROST

Touch to defrost food by weight.

## NUMBER PADS

Used to enter clock, cooking time, temperature, etc.

## MICROWAVE POWER LEVEL

Press to select microwave power level.

## GRILL/MICRO.+ GRILL

Press to set a grill or combination cooking program.

## TURN GRILL/MICRO.+TURN GRILL

Press to set turn grill or micro.+ turn grill cooking program.

## CONVECTION

Press to program convection cooking.

## CONVECTION+TURN GRILL

Press to set a program combining convection and turn grill features.

## CONVECTION+TURN GRILL+MICRO.

Press to set a triple-feature cooking program.

## MICRO.+CONVECTION

Press to select one of four combination cooking settings.

## STEAM CLEAN/ DEODORIZE/ DISINFECT

Press to set STEAM CLEAN/ DEODORIZE/ DISINFECT function.

## KEEP WARM/ FERMENT

Press to set KEEP WARM/ FERMENT program.

## POWER SAVE

Press to set POWER SAVE program.

## TIMER/CLOCK

Used to set the clock and the oven timer.

## START/ EXPRESS COOK

Press to start cooking program or to start the oven quickly at full power.

## STOP/RESET

Touch to stop cooking program or clear all previous settings before cooking starts.

## HOW TO SET THE OVEN CONTROLS

- During cooking, if press STOP/RESET pad once or open the door, the program will be paused, then press START/EXPRESS COOK pad to resume, but if press STOP/RESET pad twice, the program will be canceled.
- After ending cooking, the system will sound beeps to remind user every two minutes until user press any pad or open the door.

## SETTING THE CLOCK

This is a clock with both 12 hour cycle and 24 hour cycle.

1. In waiting mode, press TIMER/CLOCK pad for 3 seconds it will work by 12 hour cycle.  
(If you want to select 24 hour cycle, press this pad again.)
2. Use the number pads “10、1MINUTES”、“10、1SECONDS” to enter the correct time.
3. Press TIMER/CLOCK pad to confirm.

## KITCHEN TIMER

Your microwave oven can be used as a kitchen timer. Use the timer for timing up to 99 minutes 99 seconds.

1. Press TIMER/CLOCK pad once.
2. Use number pads to enter the time to be counted down.
3. Press START/EXPRESS COOK pad to confirm.

**Note:** You can check the timer by pressing TIMER/CLOCK pad, time countdown can be seen on the display for 5 seconds before clock or cooking time returns to exhibit; you can cancel the timer by pressing STOP/RESET pad during the 5 seconds.

## MICROWAVE COOKING

The longest cooking time is 99 minutes and 99 seconds. Microwave cooking allows you to customize cooking power and time. First, you select a power level by pressing the MICROWAVE POWER LEVEL pad a number of times (see the table below). Then you set the cooking time using the number pads before pressing the START/EXPRESS COOK pad.

Suppose you want to cook for 5 minute at 60% power level.

1. In waiting mode, place food into oven, and close it.
2. Press MICROWAVE POWER LEVEL pad a number of times to set power.

Press MICROWAVE POWER LEVEL Pad	Power (Display)	Press MICROWAVE POWER LEVEL Pad	Power (Display)
Once	100%(P100)	7 times	40%(P-40)
Twice	90%(P-90)	8 times	30%(P-30)
3 times	80%(P-80)	9 times	20%(P-20)
4 times	70%(P-70)	10 times	10%(P-10)
5 times	60%(P-60)	11 times	0% (P-00)
6 times	50%(P-50)		

3. Press number pads to enter cooking time until the correct cooking time (5:00) is displayed.

- Press START/EXPRESS COOK pad to confirm.





**Note:**

- You can press MICROWAVE POWER LEVEL pad to check present power during running process.
- You also can only input cooking time without pressing MICROWAVE POWER LEVEL pad, system will work at full power level automatically after you press START/EXPRESS COOK pad.

## GRILL/ MICROWAVE +GRILL

The longest cooking time is 99 minutes and 99 seconds.

- In waiting mode, place food into oven, and close it.
- Press GRILL / MICRO + GRILL pad a number of times.

Press GRILL / MICRO+GRILL	FUNCTION	Indicators On Display	Cooking time	
			Microwave	Grill
Once	GRILL		/	100%
Twice	COMBINATION 1	Co-1  	30%	70%
Thrice	COMBINATION 2	Co-2  	55%	45%









- Press the number pads to enter the cooking time.
- Press START/EXPRESS COOK pad to confirm.

**Note:** During combination cooking, you can see the programmed setting by pressing the pad GRILL/MICRO+GRILL once.

## TURN GRILL/MICRO+TURN GRILL

The longest cooking time is 99 minutes and 99 seconds.

- In waiting mode, place food into oven, and close it.
- Press TURN GRILL/MICRO+TURN GRILL pad a number of times.

Press TURN GRILL/MICRO+TU RN GRILL Pad	FUNCTION	Indicators On Display	Cooking time	
			Microwave	Grill
Once	TURN GRILL	 	/	100%
Twice	COMBINATION 1	Co-1   	30%	70%
Thrice	COMBINATION 2	Co-2   	55%	45%

- Press the number pads to enter the cooking time.
- Press START/EXPRESS COOK to confirm.

**Note:** During combination cooking, you can see the programmed power by pressing the pad TURN GRILL/MICRO+TURN GRILL once.

## CONVECTION

The longest cooking time is 99 minutes and 99 seconds. During CONVECTION cooking, hot air is circulated throughout the oven cavity to brown and make crisp foods quickly and evenly. This oven can be programmed for ten different cooking temperatures: 110°C~200°C.

### To Cook with Convection

To cook with convection, press CONVECTION pad repeatedly to enter the desired convection temperature.

Suppose you want to cook at 180°C for 25 minutes.

1. In waiting mode, place food into oven, and close it.
2. Press CONVECTION pad repeatedly until the display shows 180C and .
3. Press number pads to enter cooking time.
4. Press START/EXPRESS COOK pad to confirm.

### To Preheat and Cook with Convection

Your oven can be programmed to combine preheating and convection cooking operations.

Suppose you want to preheat at 170°C and then cook for 35 minutes.



1. Press CONVECTION pad repeatedly until the display shows 170C and .
2. Press START/EXPRESS COOK pad. Beeps will be sounded when the designated temperature is reached.
3. Open the door and place container of food at the center of the turntable.
4. Press number pads to enter cooking time.
5. Press START/EXPRESS COOK pad to confirm.

**Note:** The longest time for preheat is 30 minutes (can't be set). Temperature can be checked by pressing CONVECTION pad during the running.

## MICROWAVE +CONVECTION

The longest cooking time is 99 minutes and 99 seconds. Press MICRO+ CONVECTION pad repeatedly to select program convection temperature (110°C→140°C→170°C→200°C).

Suppose you want to bake a cake for 24 minutes on 170°C.

1. In waiting mode, place food into oven, and close it.
2. Press MICRO +CONVECTION pad repeatedly until the display shows 170C,  and .
3. Press number pads to enter cooking time.
4. Press START/EXPRESS COOK pad to confirm.

**Note:** Temperature can be checked by pressing MICRO+CONVECTION pad during the running.



## CONVECTION+TURN GRILL

The longest cooking time is 99 minutes and 99 seconds. During CONVECTION+TURN GRILL cooking, hot air is circulated throughout the oven cavity to brown and make crisp foods quickly and evenly. This oven can be programmed for ten different cooking temperatures: 110°C~200°C.

### To Cook with Convection

To cook with convection, press CONVECTION+TURN GRILL pad repeatedly to enter the desired convection temperature.



Suppose you want to cook at 180°C for 25 minutes.

1. In waiting mode, place food into oven, and close it.
2. Press CONVECTION+TURN GRILL pad repeatedly until the display shows 180C,  and .
3. Press number pads to enter cooking time.
4. Press START/EXPRESS COOK pad to confirm.

### To Preheat and Cook with Convection

Your oven can be programmed to combine preheating and convection cooking operations.

Suppose you want to preheat at 170°C and then cook for 35 minutes.



1. Press CONVECTION+TURN GRILL pad repeatedly until the display shows 170C,  and .
2. Press START/EXPRESS COOK pad. Beeps will be sounded when the designated temperature is reached.
3. Open the door and place container of food at the center of the turntable.
4. Press number pads to enter cooking time.
5. Press START/EXPRESS COOK pad to confirm.

**Note:** The longest time for preheat is 30 minutes (can't be set). Temperature can be checked by pressing CONVECTION+TURN GRILL pad during the running.

## CONVECTION+TURN GRILL+MICRO

The longest cooking time is 99 minutes and 99 seconds. Press CONVECTION+TURN GRILL+MICRO pad repeatedly to select program convection temperature (110°C→140°C→170°C→200°C).

Suppose you want to bake a cake for 30 minutes on 140°C.

1. In waiting mode, place food into oven, and close it.
2. Press CONVECTION+TURN GRILL+MICRO pad repeatedly until the display shows 140C,  and .
3. Press number pads to enter cooking time.
4. Press START/EXPRESS COOK pad to confirm.

**Note:** Temperature can be checked by pressing CONVECTION+TURN GRILL+MICRO pad during the running.

## WEIGHT DEFROST

Suppose you want to defrost frozen meat.

1. In waiting mode, place food into oven, and close it.
2. Press WEIGHT DEFROST pad repeatedly to select food weight (100g~1800g).
3. Press START/EXPRESS COOK pad to confirm.

**Note:** During defrosting program, the system will pause and sound beeps to remind user to turn food over for uniform defrost, and then press START/EXPRESS COOK pad to resume the defrosting.

## MENU COOK

For food or the following cooking mode, it is not necessary to program the duration and the cooking power. It is sufficient to indicate the type of food that you wish to cook as well as the weight of this food.

1. In standby mode, press the individual icon pad once and then press repeatedly to select the weight or amount of food.
2. Press START/EXPRESS COOK pad to start.

### Auto Cook Menu

Food Icons	Weight Range(press the icon pad)				Remarks
	Once	Twice	Thrice	4times	
Cake	475g	Only one choice.			1. For beverage, parameters on the display are not food weight but number of servings. 2. For COOKIES, you need to preheat at 160°C and cook with convection.
Reheat	7 choices (200g ~ 800g)				
Beverage	1	2	3	200ml/cup	
Rice	150g	300g	450g	600g	
Popcorn	100g	Only one choice.			
Pizza	150g	300g	450g		
BBQ	5 choices (100g ~ 500g)				
Cookies	Press once, only one choice.				

**Notes:** The weight range quoted above is for reference only. Please always take the weight and cooking time actually shown on the screen of your oven as the correct settings.

Voltage fluctuation may cause food not done well, in such case, adjust the cooking time manually.

## OTHER CONVENIENT FEATURES

### CHILD PROOF LOCK

The child proof lock prevents unsupervised operation by little children.

To set the child proof lock: Press STOP/RESET pad for 3 seconds, then a beep will sound and the indicator light will come on. In the lock state, all pads are disabled.

To cancel the child proof lock: Press STOP/RESET pad for 3 seconds, then a beep will sound and the indicator light will turn off.

### EXPRESS COOK

Use this feature to program the oven to microwave food at 100% power conveniently.

Press START/EXPRESS COOK pad in quick succession to set the cooking time (up to 10minutes).

During cooking, you can press this pad to add cooking time. (each add 30 seconds)

### KEEP WARM

It helps you to keep food warm easily. The default setting is convection working for 30 minutes at 50°C temperature.

1. Place a convection container with food into the oven.
2. Touch KEEP WARM/FERMENT pad once.
3. Press START/EXPRESS COOK pad.

**Note:** If you want to change the default setting time, please set the time using the number pads before

pressing the START/EXPRESS COOK pad. (up to 99 minutes 99 seconds)

### **FERMENT**

It helps you to ferment food easily. The default setting is convection working for 30 minutes at 50°C temperature.

1. Place a larger and covered convection container with food into the oven.
2. Touch KEEP WARM/FERMENT pad twice.
3. Press START/EXPRESS COOK pad.

**Note:** If you want to change the default setting time, please set the time using the number pads before pressing the START/EXPRESS COOK pad. (up to 99 minutes 99 seconds)

### **STEAM CLEAN**

It helps you to clean the oven easily. The default setting is microwave working for 5 minutes at full power level.

1. Place a microwave container with 200ml water into the oven.
2. Press STEAM CLEAN/ DEODORIZE/DISINFECT pad once.
3. Press START/EXPRESS COOK pad.

**Note:** After program ending, move the microwave container and glass tray away. Use a soft and dry cloth to clean the oven cavity and door.

### **DEODORIZE**

This function can flash the air in the oven. Empty the oven before using it.

1. Make sure the oven is empty, and then close the door.
2. Touch STEAM CLEAN/ DEODORIZE/DISINFECT pad twice.
3. Touch START/EXPRESS COOK pad.

### **DISINFECT**

1. Touch STEAM CLEAN/ DEODORIZE/DISINFECT pad thrice.
2. Touch START/ EXPRESS COOK pad.

### **POWER SAVE**

When the oven isn't used, you can set power save mode.

In standby state, press POWER SAVE pad, then the display will be black. The system enters into power save mode until you press any pad or open the door.

### **AUTOMATIC PROTECTION MECHANISM**

1. When the system enters into super high temperature protection status, the digital display shows "E01" and continues to beep till the system comes back to normal condition and then press "STOP/RESET".
2. When the system enters into super low temperature protection status, the digital display shows "E02" and continues to beep till the system comes back to normal condition and then press "STOP/RESET".
3. The system enters into protection mode when the system sensor is Short Circuited. The display



shows "E03" and continues to beep until pressing "STOP/RESET" button. Call consumer service to check and replace the faulty sensor.

### **COOLING FEATURE**

This system of the microwave oven has the feature of cooling. As for any cooking mode which cooking time above 2 minutes, after finishing cooking, the oven fan will work about 3 minutes automatically to cool the oven for prolonging the life of the oven.

## **CLEANING AND CARE**

1. Turn off the oven and remove the power plug from the wall socket before cleaning.
2. Keep the inside of the oven clean. When food splatters or spilled liquids adhere to oven walls, wipe with a damp cloth. Mild detergent may be used if the oven gets very dirty. Avoid the use of spray and other harsh cleaners as they may stain, streak or dull the door surface.
3. The outside surfaces should be cleaned with a damp cloth. To prevent damage to the operating parts inside the oven, water should not be allowed to seep into the ventilation openings.
4. Wipe the door and window on both sides, the door seals and adjacent parts frequently with a damp cloth to remove any spills or spatters. Do not use abrasive cleaner.
5. Do not allow the control panel to become wet. Clean with a soft, damp cloth. When cleaning the control panel, leave oven door open to prevent oven from accidentally turning on.
6. If steam accumulates inside or around the outside of the oven door, wipe with a soft cloth. This may occur when the microwave oven is operated under high humidity condition. And it is normal.
7. It is occasionally necessary to remove the glass tray for cleaning. Wash the tray in warm sudsy water or in a dishwasher.
8. The roller ring and oven floor should be cleaned regularly to avoid excessive noise. Simply wipe the bottom surface of the oven with mild detergent. The roller ring may be washed in mild sudsy water or dishwasher. When removing the roller ring from cavity floor for cleaning, be sure to replace in the proper position.
9. Remove odors from your oven by combining a cup of water with the juice and skin of one lemon in a deep microwaveable bowl, microwave for 5 minutes. Wipe thoroughly and dry with a soft cloth.
10. When it becomes necessary to replace the oven light, please consult a dealer to have it replaced.
11. The oven should be cleaned regularly and any food deposits removed. Failure to maintain the oven in a clean condition could lead to deterioration of the surface that could adversely affect the life of the appliance and possibly result in a hazardous situation.
12. Please do not dispose this appliance into the domestic rubbish bin, it should be disposed to the particular disposal center provided by the municipalities.
13. When the microwave oven with grill function is first used, it may produce slight smoke and smell. This is a normal phenomenon because the oven is made of a steel plate coated with lubricating oil, and the new oven will produce fumes and odor generated by burning the lubricating oil. This phenomenon will disappear after a period of using.



